

# Ultra Low Noise, High Current E-PHEMT

## 0.45-6GHz

### Product Features

- Low Noise Figure, 0.5 dB
- Gain, 17 dB at 2 GHz
- High Output IP3, +33 dBm
- Output Power at 1dB comp., +20 dBm
- High Current, 60mA
- Wide bandwidth
- External biasing and matching required
- May be used as replacement <sup>a,b</sup> for Avago ATF-54143



## SAV-541+

CASE STYLE: MMM1362  
PRICE: \$1.39 ea. QTY. (10-49)

### Typical Applications

- Cellular
- ISM
- GSM
- WCDMA
- WiMax
- WLAN
- UNII and HIPERLAN

+ RoHS compliant in accordance with EU Directive (2002/95/EC)

The +Suffix has been added in order to identify RoHS Compliance. See our web site for RoHS Compliance methodologies and qualifications.

### General Description

SAV-541+ is an ultra-low noise, high IP3 transistor device, manufactured using E-PHEMT\* technology enabling it to work with a single positive supply voltage. It has outstanding Noise Figure, particularly below 2.5 GHz, and when combining this noise figure with high IP3 performance in a single device it makes it an ideal amplifier for demanding base station applications. We offer these units assembled into a complete module, 50Ω in/out, noise matched and fully specified. For more information please see our TAMP family of models on our web site.

### simplified schematic and pin description

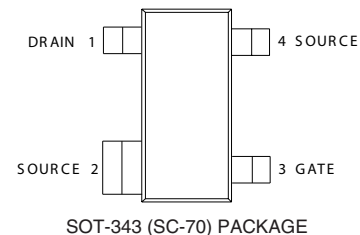
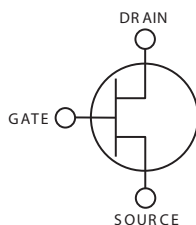

Function	Pin Number	Description
Source	2 & 4	Source terminal, normally connected to ground
Gate	3	Gate used for RF input
Drain	1	Drain used for RF output

\* Enhancement mode Pseudomorphic High Electron Mobility Transistor.

- a. Suitability for model replacement within a particular system must be determined by and is solely the responsibility of the customer based on, among other things, electrical performance criteria, stimulus conditions, application, compatibility with other components and environmental conditions and stresses.
- b. The Avago ATF-54143 part number is used for identification and comparison purposes only.

**Mini-Circuits®**  
ISO 9001 ISO 14001 AS 9100 CERTIFIED

For detailed performance specs & shopping online see web site

P.O. Box 350166, Brooklyn, New York 11235-0003 (718) 934-4500 Fax (718) 332-4661 The Design Engineers Search Engine Provides ACTUAL Data Instantly at [minicircuits.com](http://minicircuits.com)

RF/MICROWAVE COMPONENTS

Notes: 1. Performance and quality attributes and conditions not expressly stated in this specification sheet are intended to be excluded and do not form a part of this specification sheet. 2. Electrical specifications and performance data contained herein are based on Mini-Circuit's applicable established test performance criteria and measurement instructions. 3. The parts covered by this specification sheet are subject to Mini-Circuits standard limited warranty and terms and conditions (collectively, "Standard Terms"); Purchasers of this part are entitled to the rights and benefits contained therein. For a full statement of the Standard Terms and the exclusive rights and remedies thereunder, please visit Mini-Circuits' website at [www.minicircuits.com/MCLStore/terms.jsp](http://www.minicircuits.com/MCLStore/terms.jsp).

REV. C  
M123887  
ED-13377  
SAV-541+  
090803  
Page 1 of 13

Electrical Specifications at  $T_{AMB}=25^{\circ}\text{C}$ , Frequency 0.45 to 6 GHz

Symbol	Parameter	Condition	Min.	Typ.	Max.	Units
<b>DC Specifications</b>						
$V_{GS}$	Operational Gate Voltage	$V_{DS}=3\text{V}, I_{DS}=60\text{ mA}$	0.37	0.48	0.69	V
$V_{TH}$	Threshold Voltage	$V_{DS}=3\text{V}, I_{DS}=4\text{ mA}$	0.18	0.26	0.38	V
$I_{DSS}$	Saturated Drain Current	$V_{DS}=3\text{V}, V_{GS}=0\text{ V}$		1.0	5.0	$\mu\text{A}$
$G_M$	Transconductance	$V_{DS}=3\text{V}, G_m=\Delta I_{DS}/\Delta V_{GS}$ $\Delta V_{GS}=V_{GS1}-V_{GS2}$ $V_{GS1}=V_{GS}$ at $I_{DS}=60\text{ mA}$ $V_{GS2}=V_{GS1}+0.05\text{V}$	230	392	560	mS
$I_{GSS}$	Gate leakage Current	$V_{GD}=V_{GS}=-3\text{V}$			200	$\mu\text{A}$
<b>RF Specifications, <math>Z_0=50\text{ Ohms}</math> (Figure 1)</b>						
$NF^{(1)}$	Noise Figure	$V_{DS}=3\text{V}, I_{DS}=60\text{ mA}$		0.4 0.5 1.0 1.9	0.9	dB
		$V_{DS}=4\text{V}, I_{DS}=60\text{ mA}$		0.5		
Gain	Gain	$V_{DS}=3\text{V}, I_{DS}=60\text{ mA}$	15.0	23.2 17.6 12.5 8.7	18.5	dB
		$V_{DS}=4\text{V}, I_{DS}=60\text{ mA}$		17.4		
OIP3	Output IP3	$V_{DS}=3\text{V}, I_{DS}=60\text{ mA}$	30.0	32.6 33.1 33.0 31.0		dBm
		$V_{DS}=4\text{V}, I_{DS}=60\text{ mA}$		35.1		
$P_{1dB}^{(2)}$	Power output at 1 dB Compression	$V_{DS}=3\text{V}, I_{DS}=60\text{ mA}$		19.1 19.2 19.0 18.2		dBm
		$V_{DS}=4\text{V}, I_{DS}=60\text{ mA}$		21.5		

Absolute Maximum Ratings<sup>(3)</sup>

Symbol	Parameter	Max.	Units
$V_{DS}^{(4)}$	Drain-Source Voltage	5	V
$V_{GS}^{(4)}$	Gate-Source Voltage	-5 to 0.7	V
$V_{GD}^{(4)}$	Gate-Drain Voltage	-5 to 0.7	V
$I_{DS}^{(4)}$	Drain Current	120	mA
$I_{GS}$	Gate Current	2	mA
$P_{DISS}$	Total Dissipated Power	360	mW
$P_{IN}^{(5)}$	RF Input Power	17	dBm
$T_{CH}$	Channel Temperature	150	$^{\circ}\text{C}$
$T_{OP}$	Operating Temperature	-40 to 85	$^{\circ}\text{C}$
$T_{STD}$	Storage Temperature	-65 to 150	$^{\circ}\text{C}$
$\Theta_{JC}$	Thermal Resistance	160	$^{\circ}\text{C}/\text{W}$

## Notes:

- (1) Includes test board loss (tested on Mini-Circuits TB-471+ test board)
- (2) Drain current was allowed to increase during compression measurements.
- (3) Operation of this device above any one of these parameters may cause permanent damage.
- (4) Assumes DC quiescent conditions.
- (5)  $I_{GS}$  is limited to 2 mA during test.

**Mini-Circuits**<sup>®</sup>  
ISO 9001 ISO 14001 AS 9100 CERTIFIED

For detailed performance specs  
& shopping online see web site

P.O. Box 350166, Brooklyn, New York 11235-0003 (718) 934-4500 Fax (718) 332-4661 The Design Engineers Search Engine  Provides ACTUAL Data Instantly at [minicircuits.com](http://minicircuits.com)  
IF/RF MICROWAVE COMPONENTS

Notes: 1. Performance and quality attributes and conditions not expressly stated in this specification sheet are intended to be excluded and do not form a part of this specification sheet. 2. Electrical specifications and performance data contained herein are based on Mini-Circuit's applicable established test performance criteria and measurement instructions. 3. The parts covered by this specification sheet are subject to Mini-Circuits standard limited warranty and terms and conditions (collectively, "Standard Terms"); Purchasers of this part are entitled to the rights and benefits contained therein. For a full statement of the Standard Terms and the exclusive rights and remedies thereunder, please visit Mini-Circuits' website at [www.minicircuits.com/MCLStore/terms.jsp](http://www.minicircuits.com/MCLStore/terms.jsp).

## Characterization Test Circuit

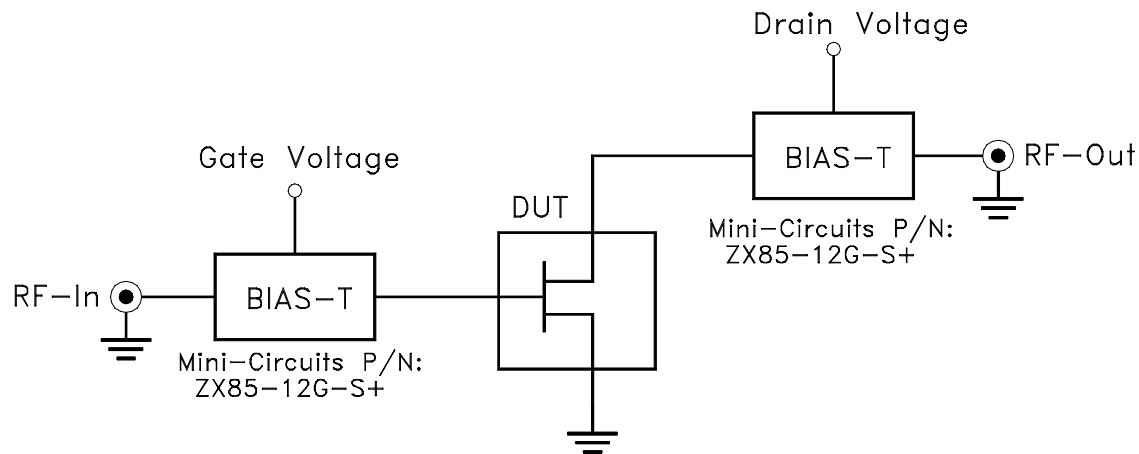
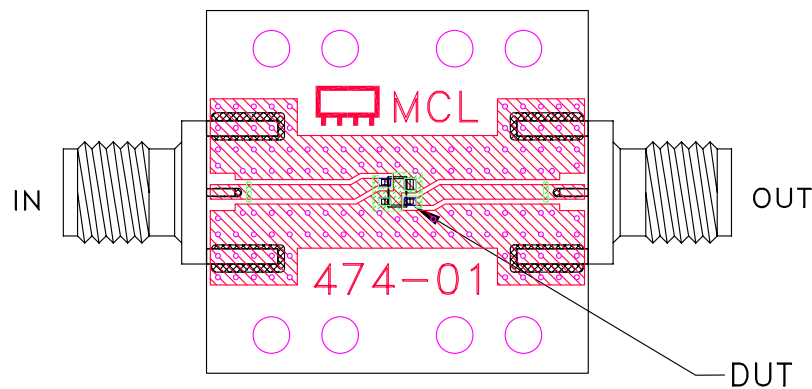

**Fig 1.** Block Diagram of Test Circuit used for characterization. (DUT soldered on Mini-Circuits Test Board TB-471+)

Gain, Output power at 1dB compression ( $P_1$  dB) and output IP3 (OIP3) are measured using R&S Network Analyzer ZVA-24. Noise Figure measured using Agilent Noise Figure meter N8975A and Noise Source N4000A.

**Conditions:**

1. Drain voltage (with reference to source,  $V_{DS}$ ) = 3 or 4V as shown.
2. Gate Voltage (with reference to source,  $V_{GS}$ ) is set to obtain desired Drain-Source current ( $I_{DS}$ ) as shown in graphs or specification table.
3. Gain:  $P_{in} = -25\text{dBm}$
4. Output IP3 (OIP3): Two tones, spaced 1 MHz apart, 0 dBm/tone at output.
5. No external matching components used.



TB-471+

**Fig 2.** Test Board used for characterization, Mini-Circuits P/N TB-471+ (Material: Rogers 4350, Thickness: 0.02")

**Mini-Circuits**  
ISO 9001 ISO 14001 AS 9100 CERTIFIED

For detailed performance specs  
& shopping online see web site

P.O. Box 350166, Brooklyn, New York 11235-0003 (718) 934-4500 Fax (718) 332-4661 The Design Engineers Search Engine  Provides ACTUAL Data Instantly at [minicircuits.com](http://minicircuits.com)

IF/RF MICROWAVE COMPONENTS

**Notes:** 1. Performance and quality attributes and conditions not expressly stated in this specification sheet are intended to be excluded and do not form a part of this specification sheet. 2. Electrical specifications and performance data contained herein are based on Mini-Circuit's applicable established test performance criteria and measurement instructions. 3. The parts covered by this specification sheet are subject to Mini-Circuits standard limited warranty and terms and conditions (collectively, "Standard Terms"); Purchasers of this part are entitled to the rights and benefits contained therein. For a full statement of the Standard Terms and the exclusive rights and remedies thereunder, please visit Mini-Circuits' website at [www.minicircuits.com/MCLStore/terms.jsp](http://www.minicircuits.com/MCLStore/terms.jsp).

Typical Performance Curves

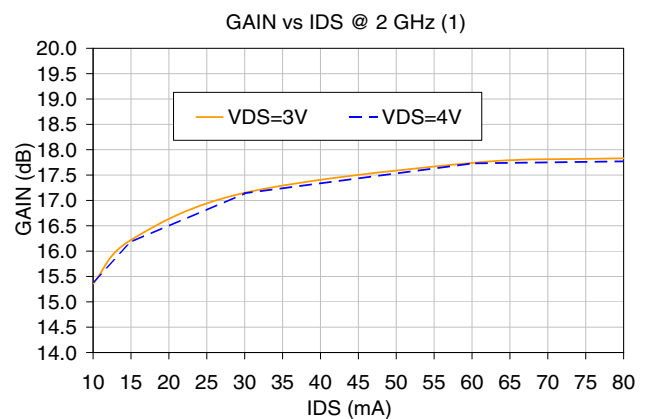
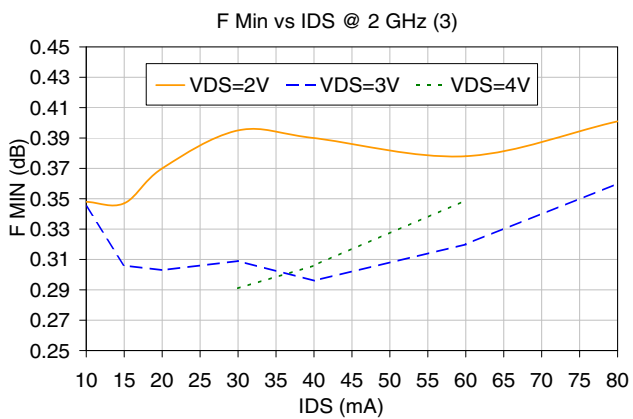
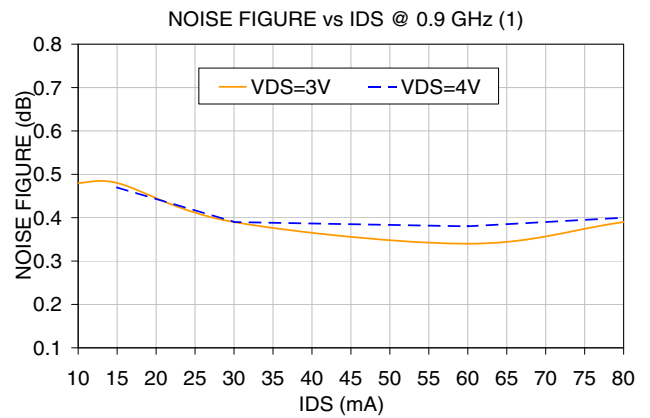
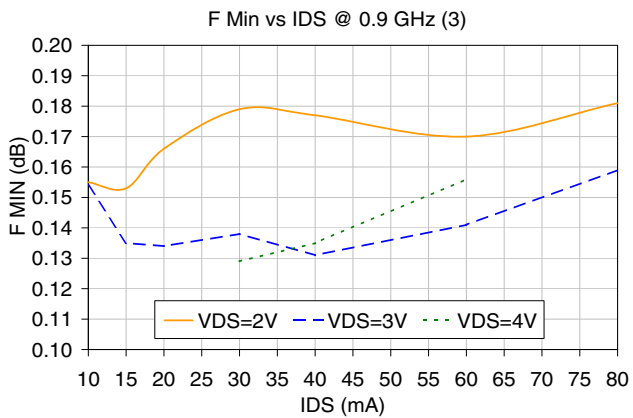
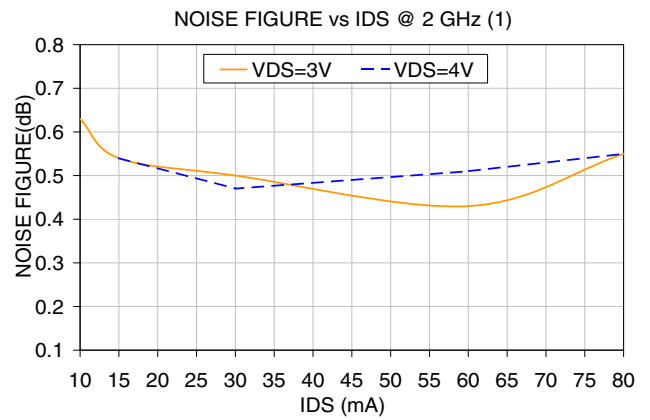
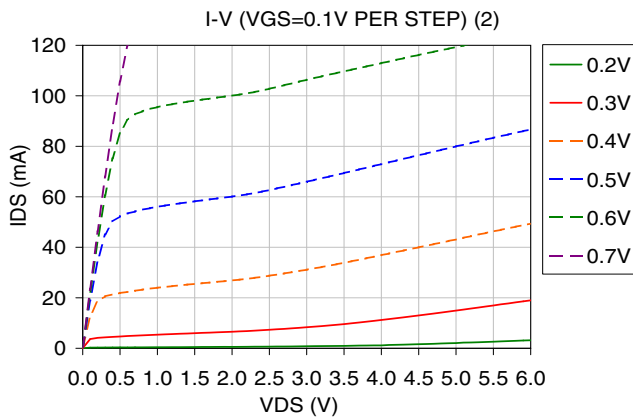

- (1) Includes test board loss, set-up and conditions per Figure 1.
- (2) Measured using HP4155B semiconductor parameter analyzer.
- (3) F Min is minimum Noise Figure.
- (4) Drain Current was allowed to increase during compression measurement.



For detailed performance specs & shopping online see web site

P.O. Box 350166, Brooklyn, New York 11235-0003 (718) 934-4500 Fax (718) 332-4661 The Design Engineers Search Engine Provides ACTUAL Data Instantly at [minicircuits.com](http://minicircuits.com)

IF/RF MICROWAVE COMPONENTS

Notes: 1. Performance and quality attributes and conditions not expressly stated in this specification sheet are intended to be excluded and do not form a part of this specification sheet. 2. Electrical specifications and performance data contained herein are based on Mini-Circuit's applicable established test performance criteria and measurement instructions. 3. The parts covered by this specification sheet are subject to Mini-Circuits standard limited warranty and terms and conditions (collectively, "Standard Terms"); Purchasers of this part are entitled to the rights and benefits contained therein. For a full statement of the Standard Terms and the exclusive rights and remedies thereunder, please visit Mini-Circuits' website at [www.minicircuits.com/MCLStore/terms.jsp](http://www.minicircuits.com/MCLStore/terms.jsp).

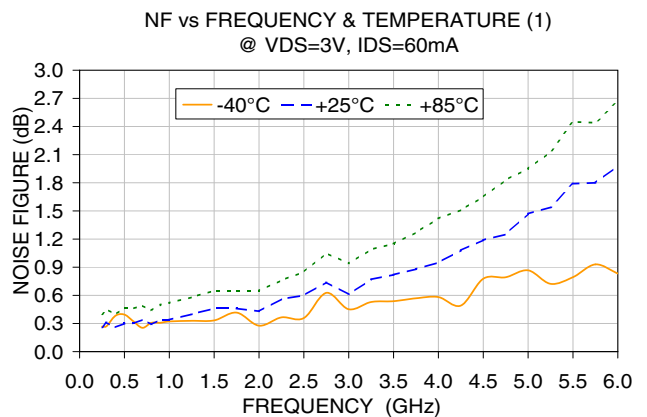
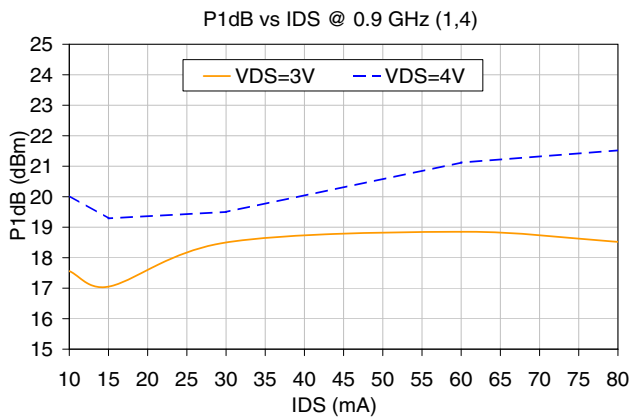
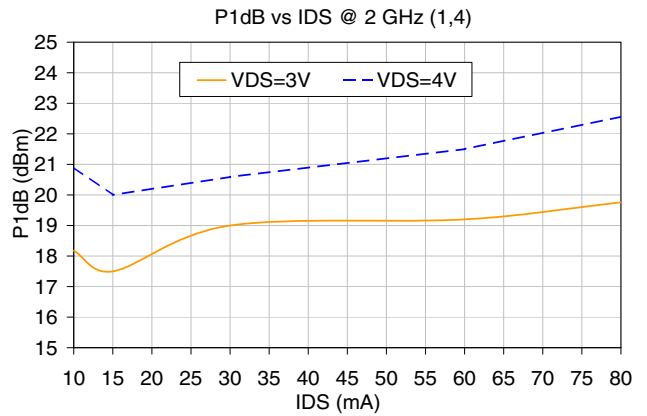
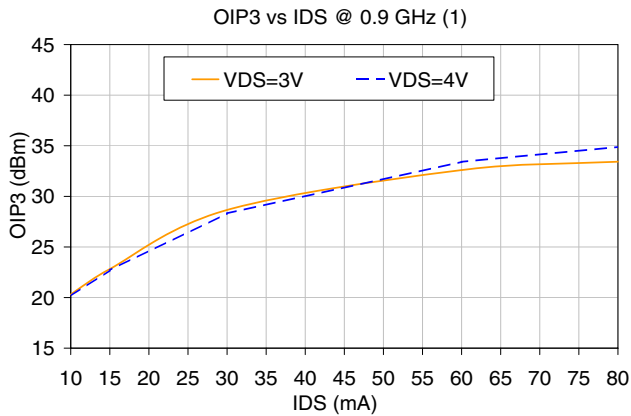
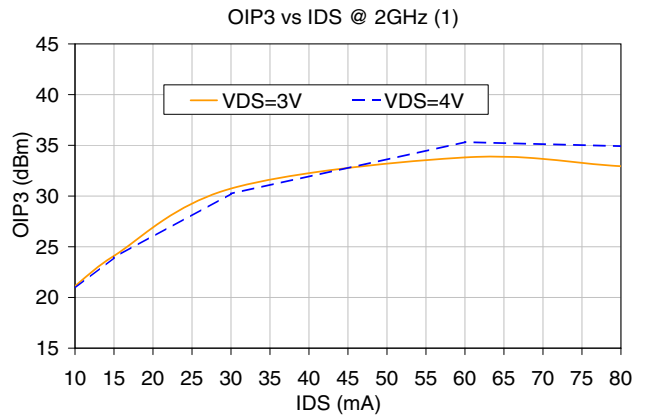
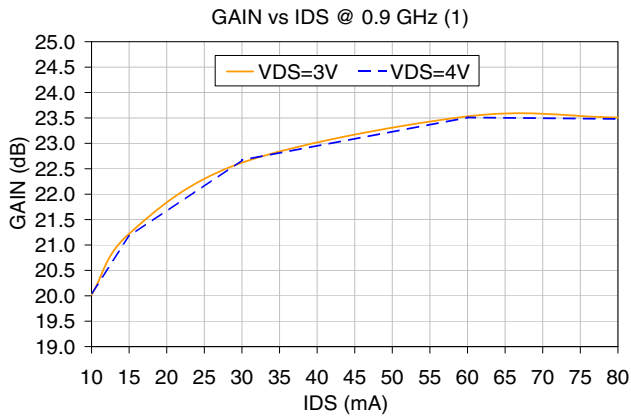

- (1) Includes test board loss, set-up and conditions per Figure 1.
- (2) Measured using HP4155B semiconductor parameter analyzer.
- (3) F Min is minimum Noise Figure.
- (4) Drain Current was allowed to increase during compression measurement.



For detailed performance specs & shopping online see web site

P.O. Box 350166, Brooklyn, New York 11235-0003 (718) 934-4500 Fax (718) 332-4661 The Design Engineers Search Engine Provides ACTUAL Data Instantly at [minicircuits.com](http://minicircuits.com)

IF/RF MICROWAVE COMPONENTS

Notes: 1. Performance and quality attributes and conditions not expressly stated in this specification sheet are intended to be excluded and do not form a part of this specification sheet. 2. Electrical specifications and performance data contained herein are based on Mini-Circuit's applicable established test performance criteria and measurement instructions. 3. The parts covered by this specification sheet are subject to Mini-Circuits standard limited warranty and terms and conditions (collectively, "Standard Terms"); Purchasers of this part are entitled to the rights and benefits contained therein. For a full statement of the Standard Terms and the exclusive rights and remedies thereunder, please visit Mini-Circuits' website at [www.minicircuits.com/MCLStore/terms.jsp](http://www.minicircuits.com/MCLStore/terms.jsp).

GAIN vs FREQUENCY & TEMPERATURE (1)  
@ VDS=3V, IDS=60mA

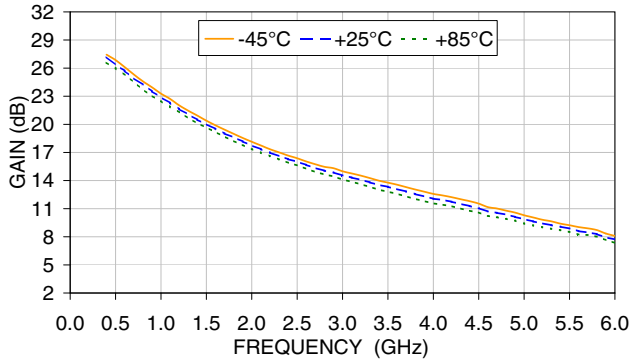

OIP3 vs FREQUENCY & TEMPERATURE (1)  
@ VDS=3V, IDS=60mA

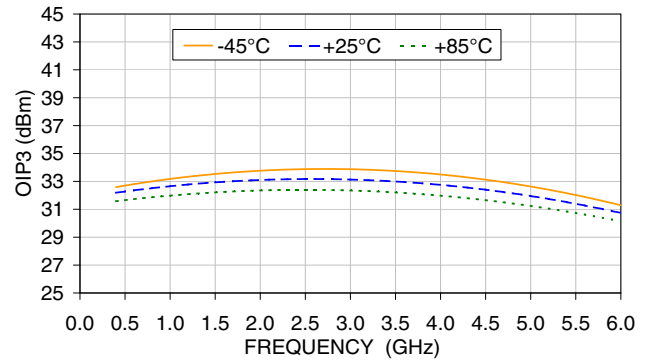

P1dB vs FREQUENCY & TEMPERATURE (1,4)  
@ VDS=3V, IDS=60mA

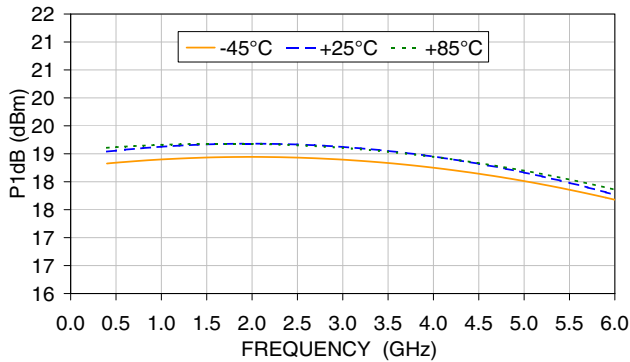

NF vs FREQUENCY & TEMPERATURE (1)  
@ VDS=4V, IDS=60mA

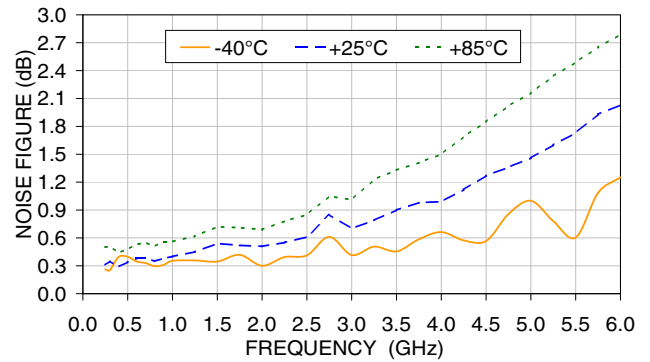

GAIN vs FREQUENCY & TEMPERATURE (1)  
@ VDS=4V, IDS=60mA

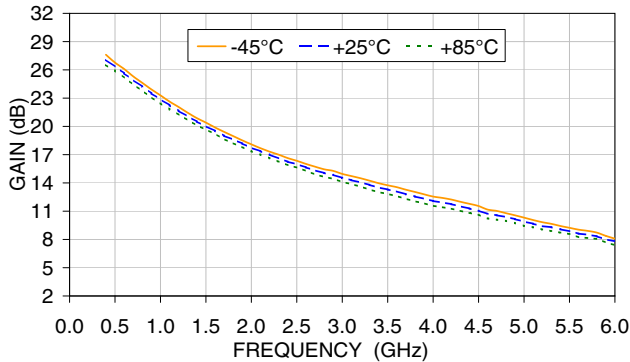

OIP3 vs FREQUENCY & TEMPERATURE (1)  
@ VDS=4V, IDS=60mA

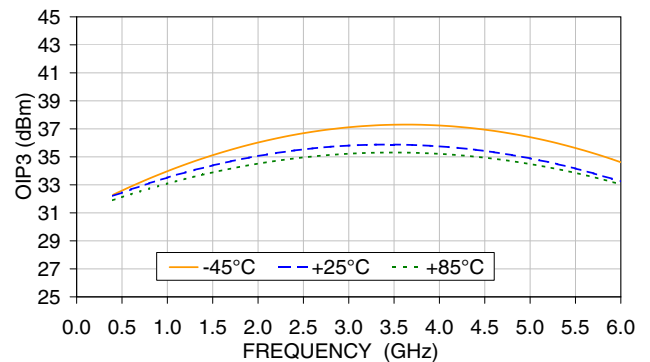

- (1) Includes test board loss, set-up and conditions per Figure 1.
- (2) Measured using HP4155B semiconductor parameter analyzer.
- (3) F Min is minimum Noise Figure.
- (4) Drain Current was allowed to increase during compression measurement.



For detailed performance specs & shopping online see web site

P.O. Box 350166, Brooklyn, New York 11235-0003 (718) 934-4500 Fax (718) 332-4661 [www.minicircuits.com](http://www.minicircuits.com) Provides ACTUAL Data Instantly at [minicircuits.com](http://minicircuits.com)

Notes: 1. Performance and quality attributes and conditions not expressly stated in this specification sheet are intended to be excluded and do not form a part of this specification sheet. 2. Electrical specifications and performance data contained herein are based on Mini-Circuit's applicable established test performance criteria and measurement instructions. 3. The parts covered by this specification sheet are subject to Mini-Circuits standard limited warranty and terms and conditions (collectively, "Standard Terms"); Purchasers of this part are entitled to the rights and benefits contained therein. For a full statement of the Standard Terms and the exclusive rights and remedies thereunder, please visit Mini-Circuits' website at [www.minicircuits.com/MCLStore/terms.jsp](http://www.minicircuits.com/MCLStore/terms.jsp).

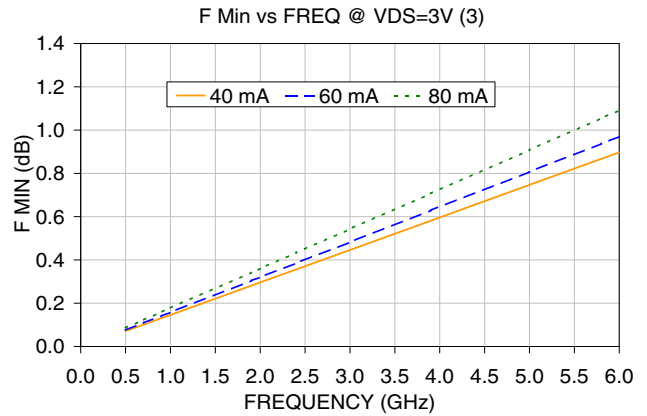
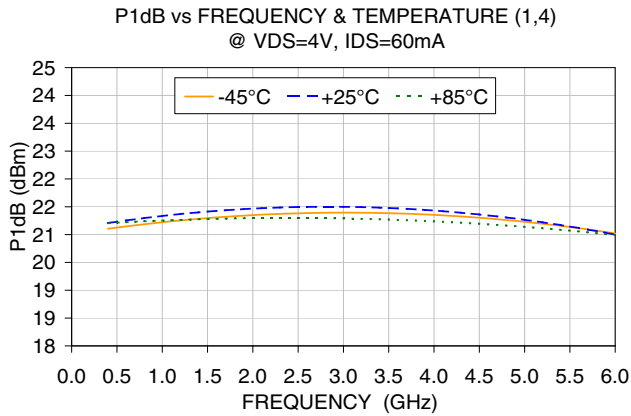

- (1) Includes test board loss, set-up and conditions per Figure 1.
- (2) Measured using HP4155B semiconductor parameter analyzer.
- (3) F Min is minimum Noise Figure.
- (4) Drain Current was allowed to increase during compression measurement.

**Reference Plane Location for S and Noise Parameters** *(see data in pages 8-11)*  
*(Refer to Application Note AN-60-040)*

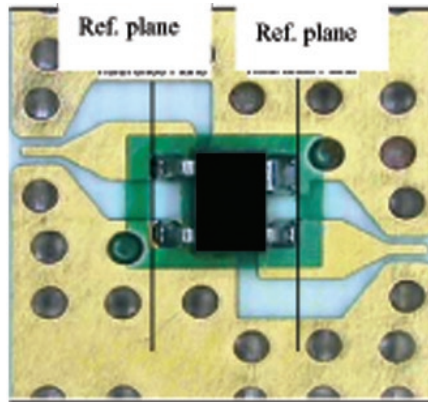

**Fig 3.** Reference Plane Location

**Notes:**

Noise parameters were measured over 0.5 to 6 GHz by Modelithics® using a solid state tuner-based noise parameter (NP) test system available from Maury Microwave. F Min, optimum source reflection coefficient and noise resistance values are calculated values based on a set of measurements made at approximately 16 different impedances. Some data smoothing was applied to arrive at the presented data set.

S-parameters were measured by Modelithics® on an Anritsu Lightning vector network analyzer over 0.1 to 18GHz using 350um pitch RF probes from GGB industries combined with customized thru-reflect-line (TRL) calibration standards. The reference plane is at the device package leads, as shown in the picture.



For detailed performance specs & shopping online see web site

**Notes:** 1. Performance and quality attributes and conditions not expressly stated in this specification sheet are intended to be excluded and do not form a part of this specification sheet. 2. Electrical specifications and performance data contained herein are based on Mini-Circuit's applicable established test performance criteria and measurement instructions. 3. The parts covered by this specification sheet are subject to Mini-Circuits standard limited warranty and terms and conditions (collectively, "Standard Terms"); Purchasers of this part are entitled to the rights and benefits contained therein. For a full statement of the Standard Terms and the exclusive rights and remedies thereunder, please visit Mini-Circuits' website at [www.minicircuits.com/MCLStore/terms.jsp](http://www.minicircuits.com/MCLStore/terms.jsp).

Typical S-parameters,  $V_{DS}=3V$  and  $I_{DS}=40\text{ mA}$  (Fig. 3)

Freq. (GHz)	S11		S21			S12		S22		MSG/MAG (dB)
	Mag.	Ang.	Mag.	Mag (dB)	Ang.	Mag.	Ang.	Mag.	Ang.	
0.1	0.99	-16.6	25.3	28.1	169.5	0.008	89.1	0.55	-14.7	34.8
0.5	0.86	-74.6	19.6	25.8	132.2	0.035	54.4	0.43	-55.3	27.5
0.9	0.75	-112.6	14.2	23.0	109.0	0.047	40.5	0.32	-83.3	24.8
1.0	0.74	-120.4	13.2	22.4	104.6	0.049	38.4	0.30	-89.5	24.3
1.5	0.68	-149.6	9.5	19.6	86.7	0.057	31.3	0.23	-114.1	22.3
1.9	0.66	-166.7	7.7	17.8	75.4	0.062	27.5	0.19	-131.2	21.0
2.0	0.66	-170.5	7.4	17.4	72.9	0.063	26.6	0.19	-135.2	20.7
2.5	0.65	172.8	6.0	15.6	61.0	0.07	22.9	0.17	-153.9	19.3
3.0	0.65	158.7	5.0	14.1	50.2	0.077	19.5	0.16	-171.3	18.2
4.0	0.66	134.4	3.8	11.6	30.0	0.091	11.9	0.16	156.7	15.8
5.0	0.68	113.5	3.0	9.7	11.1	0.104	2.7	0.18	130.5	13.3
6.0	0.71	94.7	2.5	8.0	-7.1	0.118	-7.5	0.22	109.1	11.7
7.0	0.75	77.8	2.1	6.4	-24.7	0.13	-18.3	0.28	90.7	10.5
8.0	0.78	62.4	1.8	5.0	-41.5	0.14	-29.4	0.33	74.8	9.6
9.0	0.82	47.8	1.5	3.6	-57.8	0.146	-41.0	0.40	60.0	9.0
10.0	0.85	33.7	1.3	2.3	-73.9	0.15	-52.7	0.46	46.1	8.8
11.0	0.88	20.6	1.1	1.0	-89.3	0.152	-64.4	0.53	33.2	8.7
12.0	0.90	8.4	1.0	-0.2	-104.0	0.153	-75.8	0.58	21.2	8.0
13.0	0.91	-3.5	0.9	-1.3	-118.3	0.154	-87.1	0.62	10.3	7.5
14.0	0.92	-14.4	0.8	-2.3	-131.9	0.154	-97.9	0.66	0.0	7.0
15.0	0.94	-23.0	0.7	-3.6	-143.0	0.148	-106.3	0.70	-8.7	6.5
16.0	0.95	-30.4	0.6	-4.9	-153.0	0.139	-114.2	0.75	-16.6	6.1
17.0	0.95	-39.0	0.5	-6.0	-164.0	0.134	-122.6	0.77	-25.2	5.7
18.0	0.94	-48.3	0.5	-6.9	-175.7	0.131	-131.4	0.79	-33.9	5.4

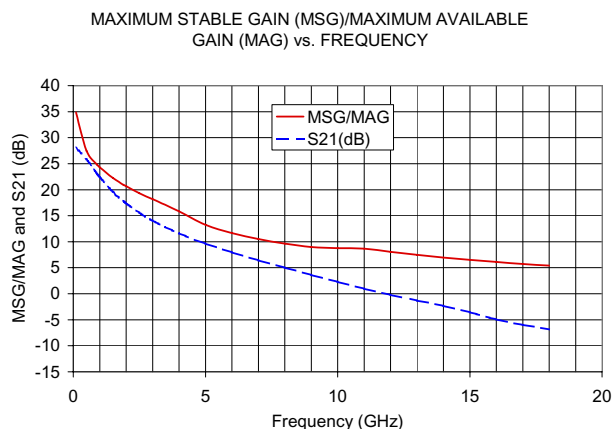

Typical Noise Parameters,  $V_{DS}=3V$  and  $I_{DS}=40\text{ mA}$  (Fig. 3)

Freq. (GHz)	F Min. (dB)	$\Gamma_{Opt}$ (Magnitude)	$\Gamma_{Opt}$ (Angle)	Rn/50	Ga
					Associated Gain (dB)
0.5	0.071	0.34	27.00	0.05	27.9
0.7	0.101	0.35	37.65	0.05	25.7
0.9	0.131	0.35	48.14	0.04	23.9
1.0	0.146	0.36	53.32	0.04	23.2
1.9	0.281	0.39	98.07	0.03	18.3
2.0	0.296	0.39	102.83	0.03	17.9
2.4	0.356	0.40	121.48	0.03	16.6
3.0	0.446	0.42	148.20	0.03	15.0
3.9	0.581	0.45	-174.52	0.05	13.4
5.0	0.747	0.48	-133.51	0.10	11.9
5.8	0.867	0.50	-106.84	0.14	10.9
6.0	0.897	0.50	-100.59	0.15	10.6

Notes:  
 F Min.: Minimum Noise Figure  
 $\Gamma_{Opt}$ : Optimum Source Reflection Coefficient  
 Rn: Equivalent noise resistance



For detailed performance specs & shopping online see web site

P.O. Box 350166, Brooklyn, New York 11235-0003 (718) 934-4500 Fax (718) 332-4661 The Design Engineers Search Engine Provides ACTUAL Data Instantly at [minicircuits.com](http://minicircuits.com)

IF/RF MICROWAVE COMPONENTS

Notes: 1. Performance and quality attributes and conditions not expressly stated in this specification sheet are intended to be excluded and do not form a part of this specification sheet. 2. Electrical specifications and performance data contained herein are based on Mini-Circuits' applicable established test performance criteria and measurement instructions. 3. The parts covered by this specification sheet are subject to Mini-Circuits standard limited warranty and terms and conditions (collectively, "Standard Terms"); Purchasers of this part are entitled to the rights and benefits contained therein. For a full statement of the Standard Terms and the exclusive rights and remedies thereunder, please visit Mini-Circuits' website at [www.minicircuits.com/MCLStore/terms.jsp](http://www.minicircuits.com/MCLStore/terms.jsp).



Typical S-parameters,  $V_{DS}=3V$  and  $I_{DS}=60\text{ mA}$  (Fig. 3)

Freq. (GHz)	S11		S21			S12		S22		MSG/MAG (dB)
	Mag.	Ang.	Mag.	Mag (dB)	Ang.	Mag.	Ang.	Mag.	Ang.	
0.1	0.99	-18.2	27.8	28.9	168.7	0.009	78.4	0.50	-14.8	35.0
0.5	0.85	-78.1	21.0	26.5	130.2	0.032	53.5	0.39	-60.2	28.1
0.9	0.74	-116.2	14.9	23.5	107.3	0.044	41.8	0.29	-90.1	25.3
1.0	0.72	-123.9	13.8	22.8	102.9	0.045	39.7	0.27	-96.8	24.9
1.5	0.67	-152.5	9.9	19.9	85.5	0.053	33.6	0.21	-122.9	22.7
1.9	0.65	-169.2	8.0	18.1	74.5	0.059	30.3	0.18	-140.6	21.4
2.0	0.65	-172.8	7.7	17.7	72.0	0.06	29.8	0.18	-144.8	21.0
2.5	0.65	170.9	6.2	15.9	60.5	0.068	26.6	0.17	-163.6	19.6
3.0	0.64	157.0	5.2	14.3	49.9	0.075	22.8	0.16	179.6	18.4
4.0	0.66	133.3	3.9	11.9	29.9	0.091	14.6	0.17	149.8	15.7
5.0	0.68	112.7	3.1	9.9	11.2	0.105	4.8	0.20	125.6	13.3
6.0	0.71	94.1	2.6	8.2	-6.8	0.12	-5.7	0.24	105.4	11.8
7.0	0.74	77.4	2.2	6.7	-24.1	0.132	-17.3	0.29	87.9	10.6
8.0	0.78	62.1	1.8	5.3	-40.8	0.142	-28.5	0.35	72.6	9.8
9.0	0.81	47.7	1.6	3.9	-56.9	0.149	-40.4	0.41	58.1	9.1
10.0	0.85	33.6	1.3	2.5	-72.8	0.152	-52.4	0.48	44.4	8.8
11.0	0.88	20.5	1.2	1.2	-88.0	0.154	-64.1	0.54	31.6	8.7
12.0	0.90	8.3	1.0	0.0	-102.6	0.154	-75.7	0.59	19.8	8.1
13.0	0.91	-3.5	0.9	-1.0	-116.9	0.155	-87.1	0.63	8.9	7.6
14.0	0.92	-14.4	0.8	-2.0	-130.4	0.155	-97.8	0.66	-1.3	7.1
15.0	0.93	-23.0	0.7	-3.2	-141.3	0.149	-106.3	0.71	-9.9	6.7
16.0	0.95	-30.5	0.6	-4.6	-151.3	0.14	-114.0	0.75	-17.6	6.3
17.0	0.95	-39.1	0.5	-5.6	-162.3	0.134	-122.4	0.77	-26.1	5.9
18.0	0.94	-48.4	0.5	-6.4	-174.0	0.132	-131.7	0.79	-34.7	5.6

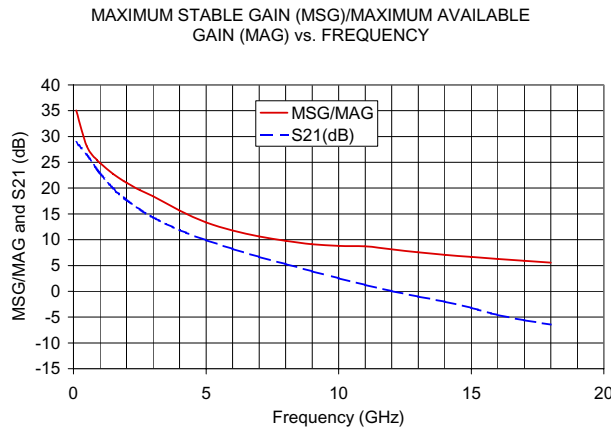

Typical Noise Parameters,  $V_{DS}=3V$  and  $I_{DS}=60\text{ mA}$  (Fig. 3)

Freq. (GHz)	F Min. (dB)	$\Gamma$ Opt (Magnitude)	$\Gamma$ Opt (Angle)	Rn/50	Ga
					Associated Gain (dB)
0.5	0.076	0.31	26.60	0.05	28.1
0.7	0.109	0.32	38.07	0.05	26.0
0.9	0.141	0.32	49.32	0.04	24.3
1.0	0.158	0.32	54.87	0.04	23.5
1.9	0.304	0.34	102.31	0.03	18.7
2.0	0.320	0.35	107.31	0.03	18.3
2.4	0.385	0.36	126.75	0.03	17.0
3.0	0.482	0.38	154.28	0.04	15.5
3.9	0.629	0.42	-168.12	0.06	13.8
5.0	0.807	0.47	-128.17	0.11	12.2
5.8	0.937	0.52	-103.27	0.16	11.2
6.0	0.970	0.53	-97.59	0.18	11.0

Notes:  
 F Min: Minimum Noise Figure  
 $\Gamma$ Opt: Optimum Source Reflection Coefficient  
 Rn: Equivalent noise resistance



For detailed performance specs & shopping online see web site

P.O. Box 350166, Brooklyn, New York 11235-0003 (718) 934-4500 Fax (718) 332-4661 The Design Engineers Search Engine Provides ACTUAL Data Instantly at [minicircuits.com](http://minicircuits.com)

IF/RF MICROWAVE COMPONENTS

Notes: 1. Performance and quality attributes and conditions not expressly stated in this specification sheet are intended to be excluded and do not form a part of this specification sheet. 2. Electrical specifications and performance data contained herein are based on Mini-Circuit's applicable established test performance criteria and measurement instructions. 3. The parts covered by this specification sheet are subject to Mini-Circuits standard limited warranty and terms and conditions (collectively, "Standard Terms"); Purchasers of this part are entitled to the rights and benefits contained therein. For a full statement of the Standard Terms and the exclusive rights and remedies thereunder, please visit Mini-Circuits' website at [www.minicircuits.com/MCLStore/terms.jsp](http://www.minicircuits.com/MCLStore/terms.jsp).

Typical S-parameters,  $V_{DS}=3V$  and  $I_{DS}=80\text{ mA}$  (Fig. 3)

Freq. (GHz)	S11		S21			S12		S22		MSG/MAG (dB)
	Mag.	Ang.	Mag.	Mag (dB)	Ang.	Mag.	Ang.	Mag.	Ang.	
0.1	0.99	-18.3	29.4	29.4	168.4	0.008	84.4	0.48	-16.4	35.6
0.5	0.84	-79.6	21.8	26.8	129.4	0.031	54.8	0.36	-62.3	28.4
0.9	0.73	-117.7	15.4	23.7	106.5	0.041	42.7	0.27	-93.1	25.7
1.0	0.71	-125.3	14.2	23.1	102.2	0.043	40.4	0.25	-99.8	25.2
1.5	0.66	-153.7	10.2	20.2	85.0	0.051	35.2	0.20	-126.4	23.0
1.9	0.65	-170.2	8.2	18.3	74.1	0.057	32.5	0.18	-144.2	21.6
2.0	0.65	-173.8	7.8	17.9	71.7	0.059	31.6	0.18	-148.3	21.3
2.5	0.64	170.2	6.3	16.1	60.2	0.066	28.2	0.16	-167.0	19.8
3.0	0.64	156.4	5.3	14.5	49.8	0.074	24.7	0.16	176.5	18.6
4.0	0.65	132.9	4.0	12.1	30.0	0.09	16.1	0.17	147.5	15.7
5.0	0.67	112.4	3.2	10.1	11.4	0.106	6.1	0.20	124.0	13.4
6.0	0.70	94.0	2.6	8.4	-6.5	0.12	-5.0	0.24	104.4	11.9
7.0	0.74	77.4	2.2	6.9	-23.8	0.133	-16.3	0.29	87.2	10.8
8.0	0.77	62.1	1.9	5.4	-40.4	0.142	-27.9	0.35	71.9	9.9
9.0	0.81	47.7	1.6	4.0	-56.4	0.15	-39.9	0.42	57.5	9.3
10.0	0.85	33.6	1.4	2.7	-72.3	0.153	-52.0	0.48	43.8	8.9
11.0	0.87	20.5	1.2	1.4	-87.4	0.155	-63.9	0.54	31.2	8.8
12.0	0.90	8.3	1.0	0.2	-102.0	0.155	-75.4	0.59	19.4	8.2
13.0	0.91	-3.5	0.9	-0.8	-116.2	0.156	-86.8	0.63	8.6	7.6
14.0	0.92	-14.4	0.8	-1.8	-129.6	0.156	-97.7	0.66	-1.6	7.2
15.0	0.93	-23.0	0.7	-3.0	-140.7	0.15	-106.2	0.71	-10.2	6.7
16.0	0.95	-30.5	0.6	-4.4	-150.6	0.14	-113.9	0.75	-17.9	6.4
17.0	0.95	-39.1	0.5	-5.4	-161.5	0.135	-122.3	0.77	-26.4	6.0
18.0	0.94	-48.5	0.5	-6.2	-173.4	0.133	-131.2	0.78	-35.0	5.7

MAXIMUM STABLE GAIN (MSG)/MAXIMUM AVAILABLE GAIN (MAG) vs. FREQUENCY

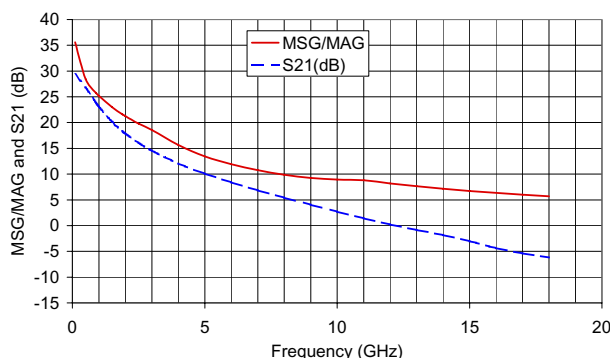

Typical Noise Parameters,  $V_{DS}=3V$  and  $I_{DS}=80\text{ mA}$  (Fig. 3)

Freq. (GHz)	F Min. (dB)	$\Gamma_{Opt}$ (Magnitude)	$\Gamma_{Opt}$ (Angle)	Rn/50	Ga
					Associated Gain (dB)
0.5	0.086	0.31	27.68	0.05	28.4
0.7	0.123	0.31	39.97	0.05	26.3
0.9	0.159	0.32	51.98	0.04	24.6
1.0	0.178	0.32	57.88	0.04	23.8
1.9	0.342	0.35	107.88	0.03	19.1
2.0	0.360	0.35	113.08	0.03	18.7
2.4	0.433	0.36	133.22	0.03	17.4
3.0	0.543	0.39	161.34	0.04	15.9
3.9	0.707	0.43	-161.16	0.07	14.1
5.0	0.908	0.49	-122.96	0.13	12.5
5.8	1.055	0.54	-100.45	0.20	11.4
6.0	1.091	0.56	-95.52	0.22	11.2

Notes:  
 F Min: Minimum Noise Figure  
 $\Gamma_{Opt}$ : Optimum Source Reflection Coefficient  
 Rn: Equivalent noise resistance



For detailed performance specs & shopping online see web site

P.O. Box 350166, Brooklyn, New York 11235-0003 (718) 934-4500 Fax (718) 332-4661 The Design Engineers Search Engine Provides ACTUAL Data Instantly at [minicircuits.com](http://minicircuits.com)

IF/RF MICROWAVE COMPONENTS

Notes: 1. Performance and quality attributes and conditions not expressly stated in this specification sheet are intended to be excluded and do not form a part of this specification sheet. 2. Electrical specifications and performance data contained herein are based on Mini-Circuits' applicable established test performance criteria and measurement instructions. 3. The parts covered by this specification sheet are subject to Mini-Circuits standard limited warranty and terms and conditions (collectively, "Standard Terms"); Purchasers of this part are entitled to the rights and benefits contained therein. For a full statement of the Standard Terms and the exclusive rights and remedies thereunder, please visit Mini-Circuits' website at [www.minicircuits.com/MCLStore/terms.jsp](http://www.minicircuits.com/MCLStore/terms.jsp).

Typical S-parameters,  $V_{DS}=4V$  and  $I_{DS}=60\text{ mA}$  (Fig. 3)

Freq. (GHz)	S11		S21			S12		S22		MSG/MAG (dB)
	Mag.	Avg.	Mag.	Avg.	dB	Mag.	Ang.	Mag.	Ang.	
0.1	0.99	-17.9	27.9	28.9	168.5	0.008	83.7	0.53	-14.7	35.2
0.5	0.85	-77.9	21.0	26.5	130.2	0.032	54.0	0.40	-57.1	28.2
0.9	0.74	-116.0	15.0	23.5	107.3	0.043	41.4	0.29	-84.8	25.5
1.0	0.72	-123.7	13.9	22.8	102.9	0.044	39.3	0.27	-90.9	25.0
1.5	0.67	-152.3	10.0	20.0	85.5	0.052	33.5	0.21	-115.1	22.8
1.9	0.65	-169.0	8.1	18.1	74.5	0.058	30.2	0.18	-131.8	21.5
2.0	0.65	-172.6	7.7	17.7	72.0	0.059	29.6	0.17	-135.9	21.1
2.5	0.64	171.1	6.2	15.9	60.4	0.066	26.5	0.15	-154.5	19.7
3.0	0.64	157.3	5.2	14.4	49.8	0.073	22.9	0.14	-171.8	18.5
4.0	0.66	133.5	3.9	11.9	29.9	0.088	15.0	0.15	156.0	15.7
5.0	0.68	112.9	3.1	10.0	11.1	0.103	5.6	0.17	129.9	13.4
6.0	0.71	94.4	2.6	8.3	-6.9	0.117	-4.9	0.21	108.6	11.9
7.0	0.74	77.7	2.2	6.8	-24.3	0.13	-16.2	0.26	90.7	10.8
8.0	0.78	62.3	1.9	5.3	-41.1	0.14	-27.3	0.32	74.9	9.9
9.0	0.81	47.9	1.6	4.0	-57.4	0.147	-39.2	0.39	60.2	9.3
10.0	0.85	33.8	1.4	2.6	-73.5	0.151	-51.1	0.46	46.3	9.5
11.0	0.88	20.6	1.2	1.3	-88.9	0.154	-62.9	0.52	33.4	8.8
12.0	0.90	8.5	1.0	0.1	-103.6	0.154	-74.4	0.57	21.5	8.2
13.0	0.91	-3.4	0.9	-1.0	-118.0	0.156	-85.9	0.61	10.6	7.6
14.0	0.92	-14.3	0.8	-2.0	-131.6	0.156	-96.8	0.65	0.3	7.1
15.0	0.94	-22.9	0.7	-3.2	-142.8	0.149	-105.4	0.70	-8.5	6.7
16.0	0.95	-30.4	0.6	-4.6	-152.9	0.14	-113.3	0.74	-16.4	6.3
17.0	0.95	-39.0	0.5	-5.6	-164.0	0.135	-121.7	0.77	-25.0	5.9
18.0	0.95	-48.3	0.5	-6.5	-175.7	0.133	-131.0	0.78	-33.7	5.5

MAXIMUM STABLE GAIN (MSG)/MAXIMUM AVAILABLE GAIN (MAG) vs. FREQUENCY

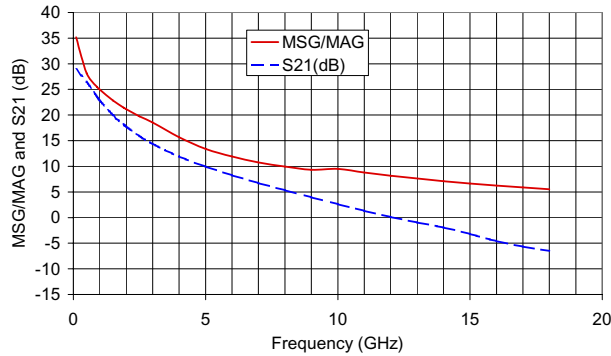

Typical Noise Parameters,  $V_{DS}=4V$  and  $I_{DS}=60\text{ mA}$  (Fig. 3)

Freq. (GHz)	F Min. (dB)	$\Gamma_{Opt}$ (Magnitude)	$\Gamma_{Opt}$ (Angle)	Rn/50	Ga
					Associated Gain (dB)
0.5	0.086	0.34	26.43	0.06	28.1
0.7	0.121	0.34	37.91	0.05	26.0
0.9	0.156	0.34	49.17	0.05	24.2
1.0	0.173	0.34	54.72	0.04	23.4
1.9	0.331	0.35	102.19	0.03	18.7
2.0	0.349	0.35	107.19	0.03	18.3
2.4	0.419	0.36	126.64	0.03	17.0
3.0	0.524	0.37	154.19	0.04	15.4
3.9	0.682	0.41	-168.19	0.06	13.7
5.0	0.875	0.47	-128.23	0.12	12.2
5.8	1.016	0.52	-103.33	0.17	11.2
6.0	1.051	0.54	-97.65	0.18	11.0

Notes:  
 F Min: Minimum Noise Figure  
 $\Gamma_{Opt}$ : Optimum Source Reflection Coefficient  
 Rn: Equivalent noise resistance



For detailed performance specs & shopping online see web site

P.O. Box 350166, Brooklyn, New York 11235-0003 (718) 934-4500 Fax (718) 332-4661 The Design Engineers Search Engine Provides ACTUAL Data Instantly at [minicircuits.com](http://minicircuits.com)

IF/RF MICROWAVE COMPONENTS

Notes: 1. Performance and quality attributes and conditions not expressly stated in this specification sheet are intended to be excluded and do not form a part of this specification sheet. 2. Electrical specifications and performance data contained herein are based on Mini-Circuit's applicable established test performance criteria and measurement instructions. 3. The parts covered by this specification sheet are subject to Mini-Circuits standard limited warranty and terms and conditions (collectively, "Standard Terms"); Purchasers of this part are entitled to the rights and benefits contained therein. For a full statement of the Standard Terms and the exclusive rights and remedies thereunder, please visit Mini-Circuits' website at [www.minicircuits.com/MCLStore/terms.jsp](http://www.minicircuits.com/MCLStore/terms.jsp).

## Product Marking

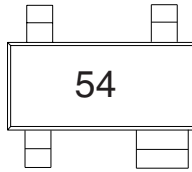

### Additional Detailed Technical Information

Additional information is available on our web site [www.minicircuits.com](http://www.minicircuits.com). To access this information enter the model number on our web site home page.

#### Performance data, graphs, s-parameter data set (.zip file)

#### Case Style: MMM1362

Plastic molded SOT-343 (SC-70) style package, lead finish: matte tin

#### Suggested Layout for PCB Design: PL-300

#### Tape & Reel: F90

#### Characterization Test Board: TB-471+

#### Environmental Ratings: ENV08T2

### ESD Rating

Human Body Model (HBM): Class 1A (250 V to < 500 V) in accordance with ANSI/ESD STM 5.1 - 2001

Machine Model (MM): Class M1 (40 V) in accordance with ANSI/ESD STM 5.2 - 1999

### MSL Rating

Moisture Sensitivity: MSL1 in accordance with IPC/JEDECJ-STD-020D

### MSL Test Flow Chart

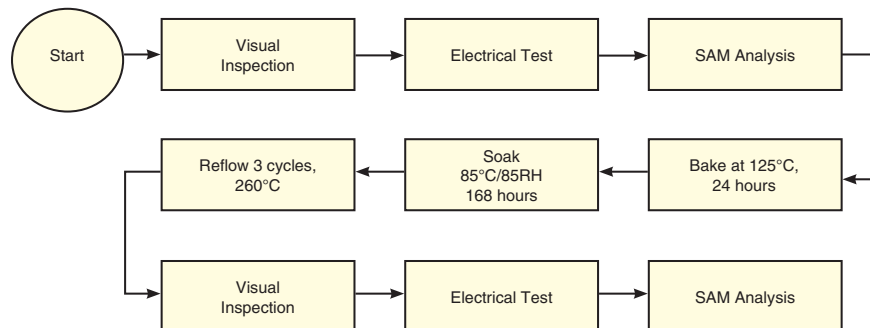

**Mini-Circuits®**  
ISO 9001 ISO 14001 AS 9100 CERTIFIED

P.O. Box 350166, Brooklyn, New York 11235-0003 (718) 934-4500 Fax (718) 332-4661 The Design Engineers Search Engine  Provides ACTUAL Data Instantly at [minicircuits.com](http://minicircuits.com)

IF/RF MICROWAVE COMPONENTS

For detailed performance specs  
& shopping online see web site

**Notes:** 1. Performance and quality attributes and conditions not expressly stated in this specification sheet are intended to be excluded and do not form a part of this specification sheet. 2. Electrical specifications and performance data contained herein are based on Mini-Circuit's applicable established test performance criteria and measurement instructions. 3. The parts covered by this specification sheet are subject to Mini-Circuits standard limited warranty and terms and conditions (collectively, "Standard Terms"); Purchasers of this part are entitled to the rights and benefits contained therein. For a full statement of the Standard Terms and the exclusive rights and remedies thereunder, please visit Mini-Circuits' website at [www.minicircuits.com/MCLStore/terms.jsp](http://www.minicircuits.com/MCLStore/terms.jsp).

Recommended Application Circuit

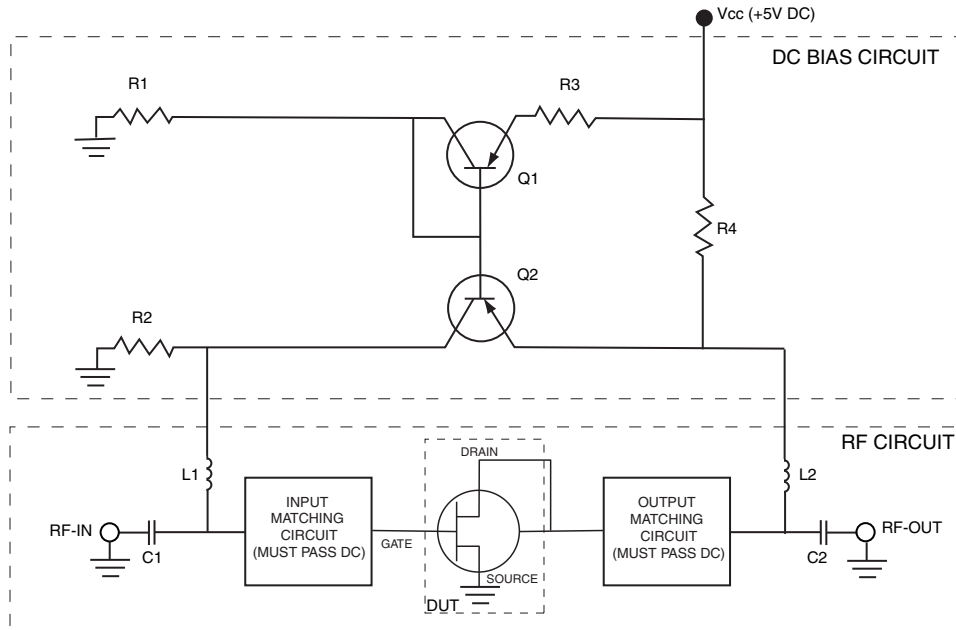

VDS, V (nom)	3	4
IDS, mA (nom)	60mA	60mA
R1	4320Ω	4320Ω
R2	4320Ω	4320Ω
R3	3570Ω	1210Ω
R4	33.2Ω	16.7Ω
Q1	MMBT3906*	MMBT3906*
Q2	MMBT3906*	MMBT3906*
C1	0.01μF	0.01μF
C2	0.01μF	0.01μF
L1**	840nH	840nH
L2**	840nH	840nH

\* Fairchild Semiconductor™ part number  
 \*\* Piconics™ part number CC45T47K240G5

Optimized Amplifier Circuits

For band specific, drop-in modules, and as an alternative to designing circuits, please refer to Mini-Circuits TAMP and RAMP series models which are based upon SAV/TAV E-PHEMT's and include all DC blocking, bias, matching and stabilization circuitry, without need for any external components.



For detailed performance specs & shopping online see web site

P.O. Box 350166, Brooklyn, New York 11235-0003 (718) 934-4500 Fax (718) 332-4661 The Design Engineers Search Engine Provides ACTUAL Data Instantly at [minicircuits.com](http://minicircuits.com)

IF/RF MICROWAVE COMPONENTS

Notes: 1. Performance and quality attributes and conditions not expressly stated in this specification sheet are intended to be excluded and do not form a part of this specification sheet. 2. Electrical specifications and performance data contained herein are based on Mini-Circuit's applicable established test performance criteria and measurement instructions. 3. The parts covered by this specification sheet are subject to Mini-Circuits standard limited warranty and terms and conditions (collectively, "Standard Terms"); Purchasers of this part are entitled to the rights and benefits contained therein. For a full statement of the Standard Terms and the exclusive rights and remedies thereunder, please visit Mini-Circuits' website at [www.minicircuits.com/MCLStore/terms.jsp](http://www.minicircuits.com/MCLStore/terms.jsp).